

## 2-Phase Hybrid Step Motor

### 57BYG 1.8°

#### DIMENSIONS 外形尺寸

(UNIT:mm)

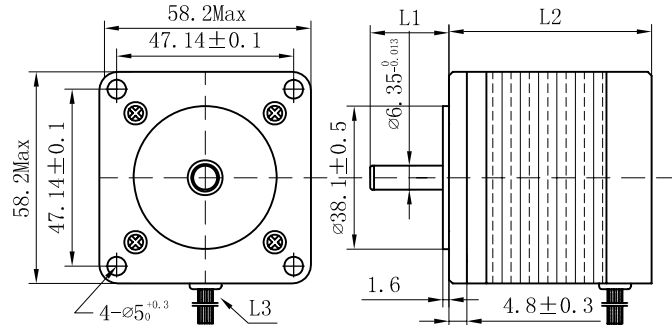

#### Electrical Specification 技术参数

型号	相数	电压	电流	电阻	电感	静转矩	定位转矩	转动惯量	重量	外形尺寸		
Model	No.of phase	Voltage	Current	Resistance	Inductance	Holding Torque	Detent Torque	Rotor Inertia	Weight	L1	L2	L3
		V	A	Ω	mH	N.m	N.m	g.cm <sup>2</sup>	kg			
57BYG007-01	4	12	0.38	32	30	0.3	0.04	60	0.45	21	41	320
57BYG007-04	4	12	0.38	32	30	0.35	0.06	118	0.6	21	51	300
57BYG008	4	4	1.3	3.1	4.4	0.5	0.06	118	0.6	21	51	320
57BYG009	4	2.4	2.4	1	1.5	0.6	0.07	145	0.65	21	56	320
57BYG059	4	4	1.6	2.5	3.5	0.6	0.07	145	0.65	25	56	300
57BYG060	2	2.6	2	1.3	3	0.62	0.06	118	0.6	20	51	300
57BYG069	4	6	1.2	5	8	0.6	0.07	145	0.65	21	56	400
57BYG070	4	5.4	1.5	3.6	6	0.9	0.09	230	1	21	76	300
57BYG084	4	12	0.6	20	22	0.6	0.07	145	0.65	21	56	300
57BYG096	2	2.7	3	0.9	1.3	0.85	0.07	145	0.65	21	56	300
57BYG707	2	4.1	2.3	1.8	6.5	1.4	0.09	230	1	21	76	300
57BYG708	2	3	3	1	2.3	1.2	0.09	230	1	21	76	400

\*以上仅为代表性产品，可供单双轴，派生产品可根据客户要求制作！

#### Frequency-torque characteristics 矩频特性

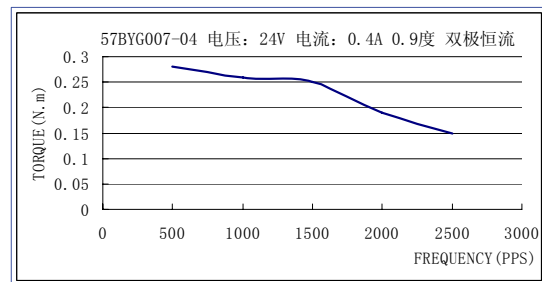
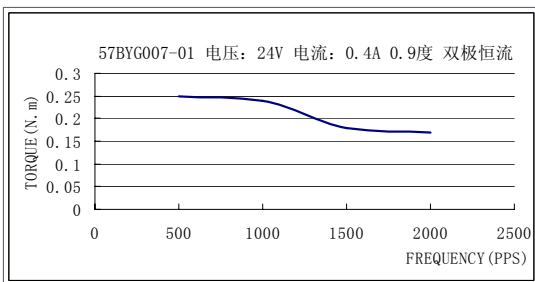

Frequency-torque characteristics 矩频特性

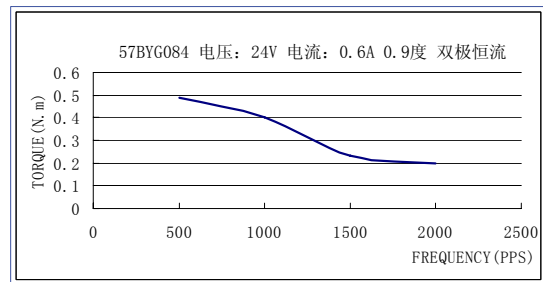
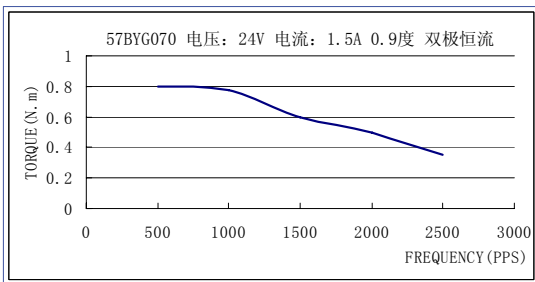
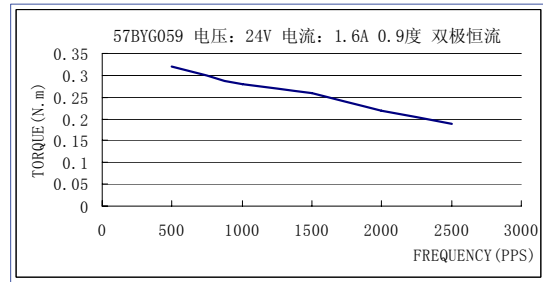
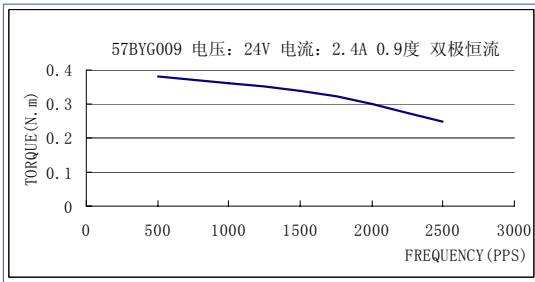

Wiring Diagram 接线图

